

Electrical Characteristics										
Frequency	Hz	50				60				
Voltage (series star)	V	380	400	415	440	415	440	460	480	
Rated power class H	kVA	30	30	28	/	33	36	36	36	
	kW	24	24	22,4	/	26,4	28,8	28,8	28,8	
Rated power class F	kVA	26	26	25	/	29	32	32	32	
	kW	20,8	20,8	20	/	23,2	25,6	25,6	25,6	
Regulation with	SR7/2	±1,5 % with any power factor and speed variations between -5% +30%								
Insulation class		H								
Execution		Brushless								
Stator winding		12 ends								
Rotor		without damping cage								
Efficiencies class H	4/4	%	87,7	88,1	88,4	/	88,9	89,2	89,4	89,8
(see graph. for details)	3/4	%	88,2	88,5	88,6	/	89,7	89,9	90,1	90,3
	2/4	%	86,4	86,5	86,5	/	88,1	88,2	88,3	88,4
	1/4	%	84,2	84	84	/	86,1	86,1	86	85,9
Reactances (f. l.cl. F)	Xd	%	182,8	165	143,1	/	202,3	196,4	179,7	165
	Xd'	%	17,06	15,4	13,35	/	18,89	18,33	16,77	15,4
	Xd''	%	9,75	8,8	7,63	/	10,79	10,47	9,58	8,8
	Xq	%	78,7	71	61,6	/	87,1	84,5	77,3	71
	Xq'	%	78,7	71	61,6	/	87,1	84,5	77,3	71
	Xq''	%	21,1	19	16,5	/	23,3	22,6	20,7	19
	X ₂	%	14,63	13,2	11,45	/	16,19	15,71	14,37	13,2
	X ₀	%	3,10	2,8	2,43	/	3,43	3,33	3,05	2,8
Short Circuit Ratio	Kcc		0,55	0,62	0,68	/	0,38	0,44	0,55	0,62
Time Constants	Td'	sec.	0,046							
	Td''	sec.	0,012							
	Tdo'	sec.	0,93							
	Tα	sec.	0,011							
Short Circuit Current Capacity		%	>300				>350			
Excitation at no load	Amp.		0,4	0,6	0,8	/	0,35	0,4	0,5	0,55
Excitation at full load	Amp.		1,75	1,96	2,1	/	1,5	1,6	1,8	1,9
Overload (long-term)		%	1 hour in a 6 hours period 110% rated load							
Overload per 20 sec.		%	300							
Stator Winding Resistance (20°C)	Ω		0,106							
Rotor Winding Resistance (20°C)	Ω		1,86							
Exciter Resistance (20 °C)	Ω		Rotor : 0,64				Stator : 10,60			
Heat dissipation at f.l.cl.H	W		3366	3242	2939	/	3296	3487	3415	3271
Telephone Interference			FHT < 2%				TIF < 45			
Radio interference			EN60034-1. For others standards apply to factory							
Waveform Distors.(THD) at f. load	LL/LN %		2,1 / 2							
Waveform Distors.(THD) at no load	LL/LN %		3,3 / 3,1							
Mechanical characteristics										
Protection			IP 23 (other protection on request)							
DE bearing			6309.2RS							
NDE bearing			6207.2RS							
Weight of wound stator assembly	kg		57							
Weight of wound rotor assembly	kg		32,4							
Weight of complete generator	kg		155							
Maximun overspeed	rpm		2250							
Unbalanced magnetic pull at f.l.cl.F	kN/mm		4,7							
Cooling air requirement	m³/min		5,3				5,8			
Inertia Constant (H)	sec.		0,068				0,081			
Noise level at 1m/7m	dB(A)		68 / 57				71 / 61			

50 Hz

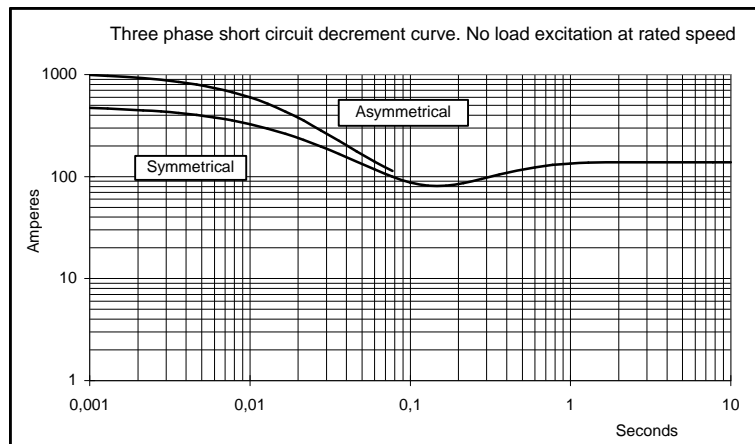

60 Hz

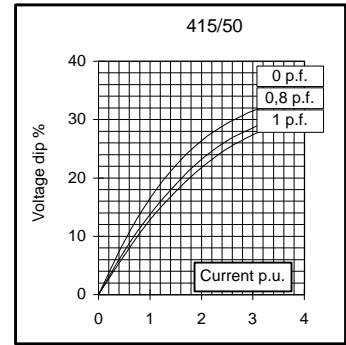
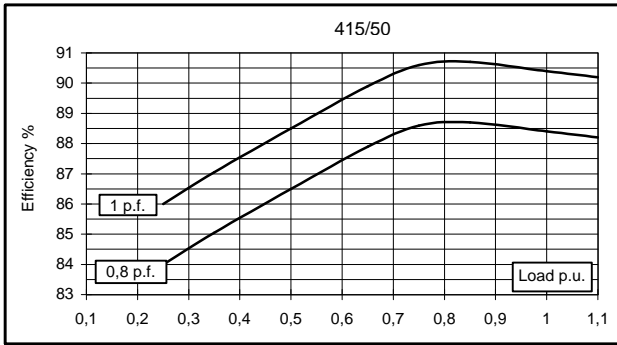
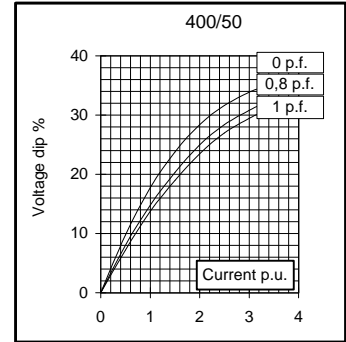
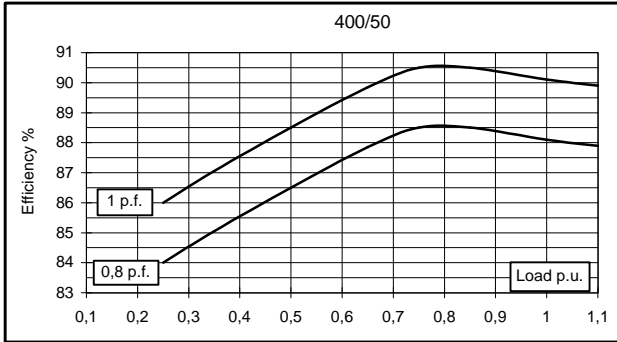
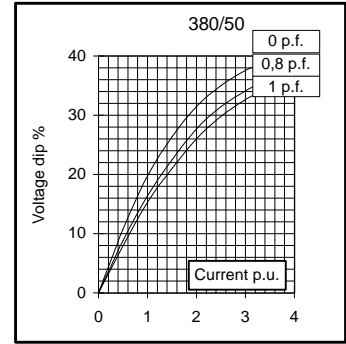
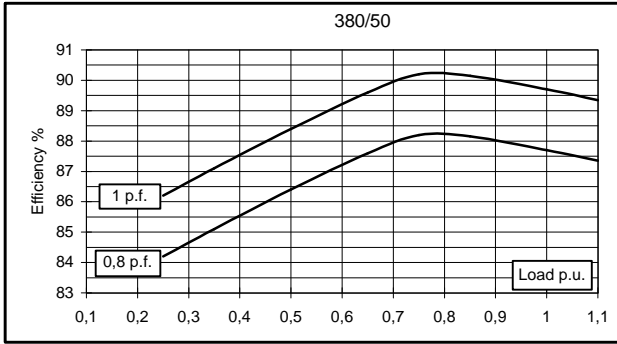
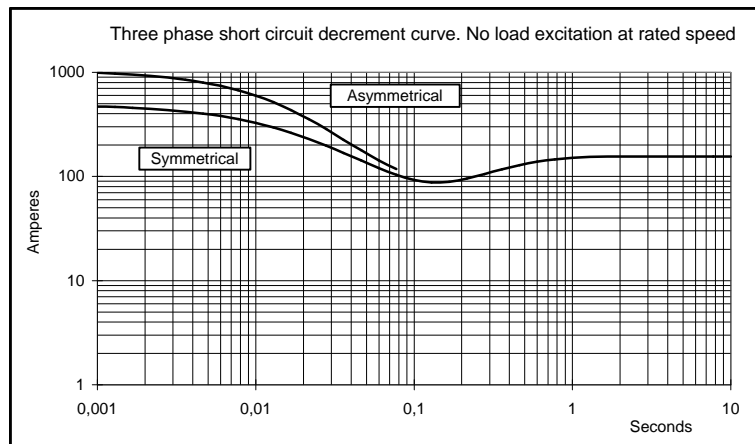
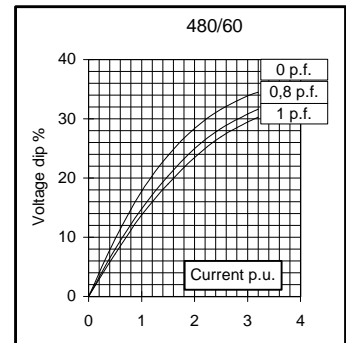
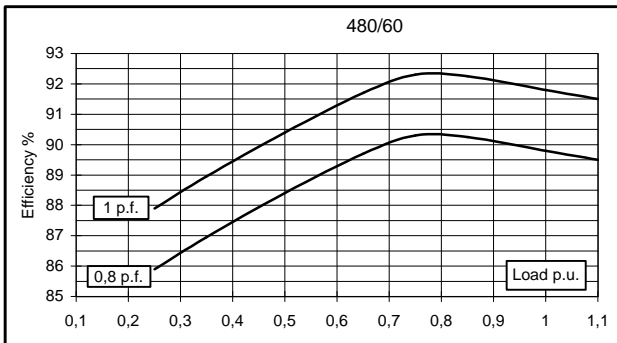
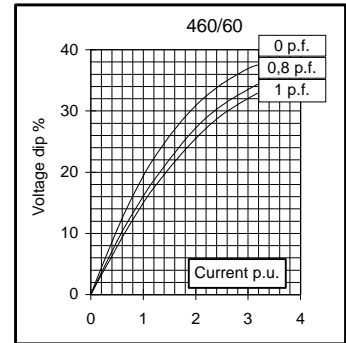
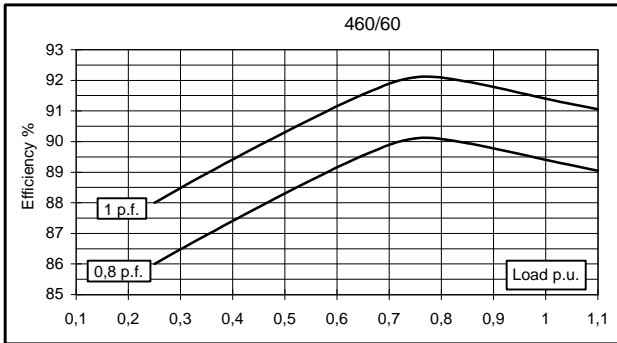
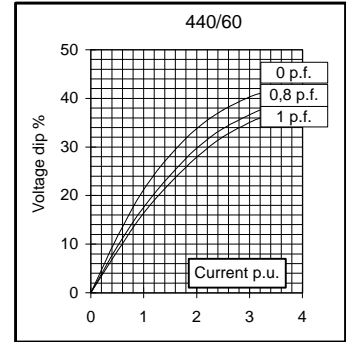
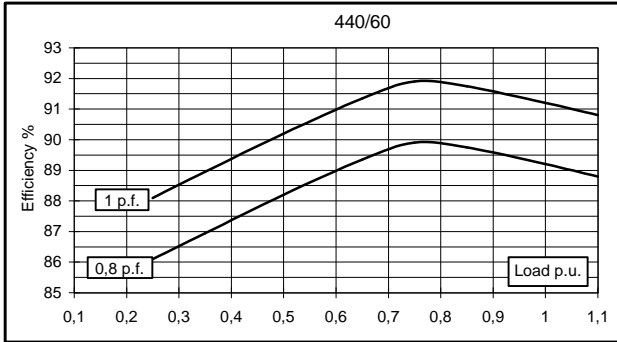
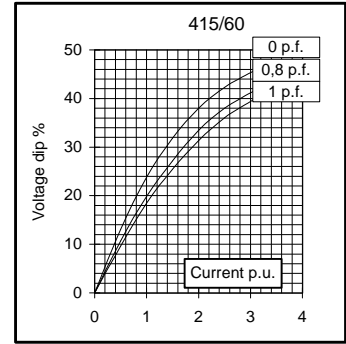
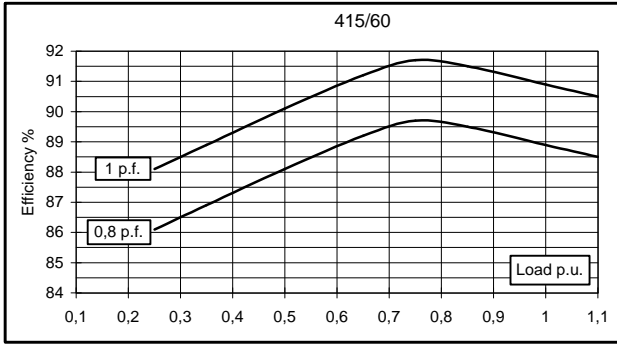

TWO BEARING MOMENTS OF INERTIA

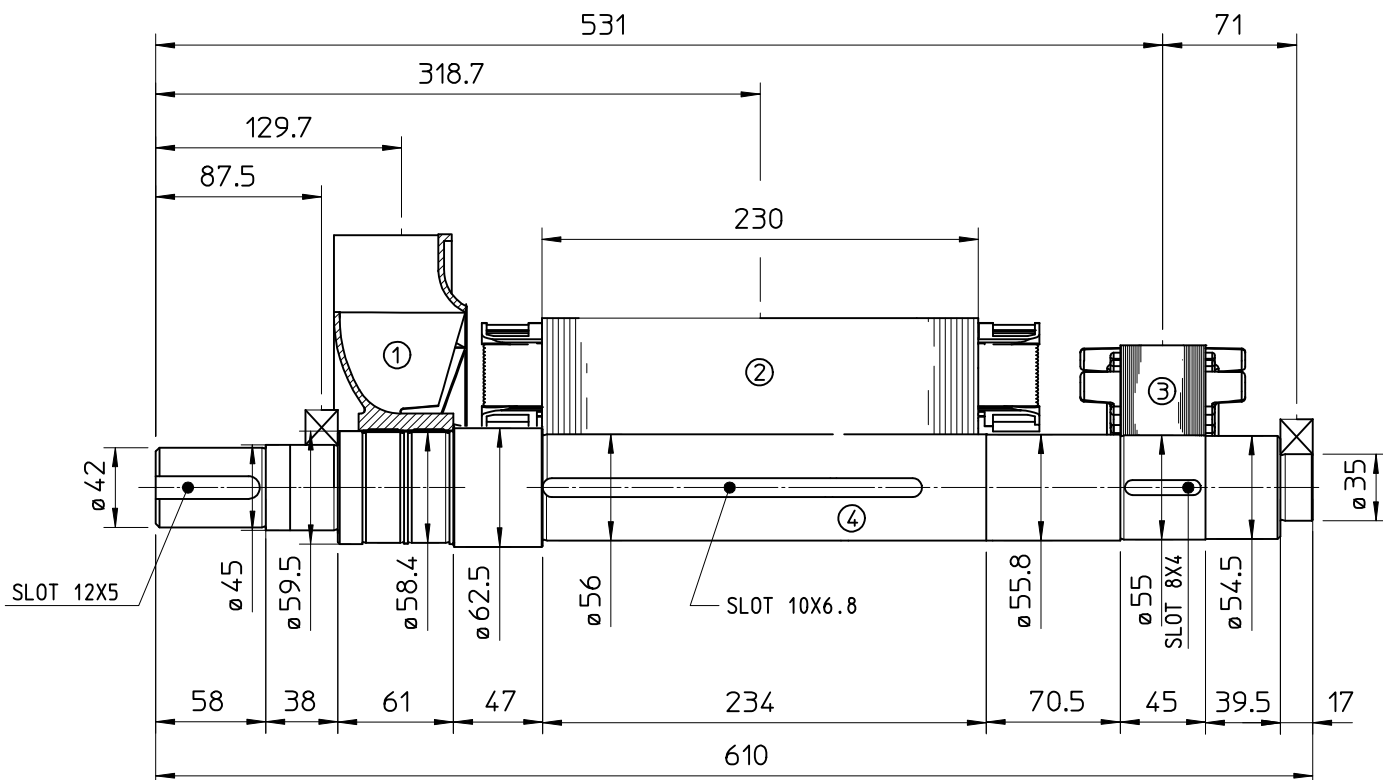

COMPONENT	WEIGHT Kg	J Kg ^m ²
1 FAN	1.2	0.0102
2 MAIN ROTOR	32.4	0.138
3 EX ROTOR	5.4	0.012
4 SHAFT	11.3	0.0043
6 TOTAL	50.3	0.1645

TWO BEARING DIMENSIONS

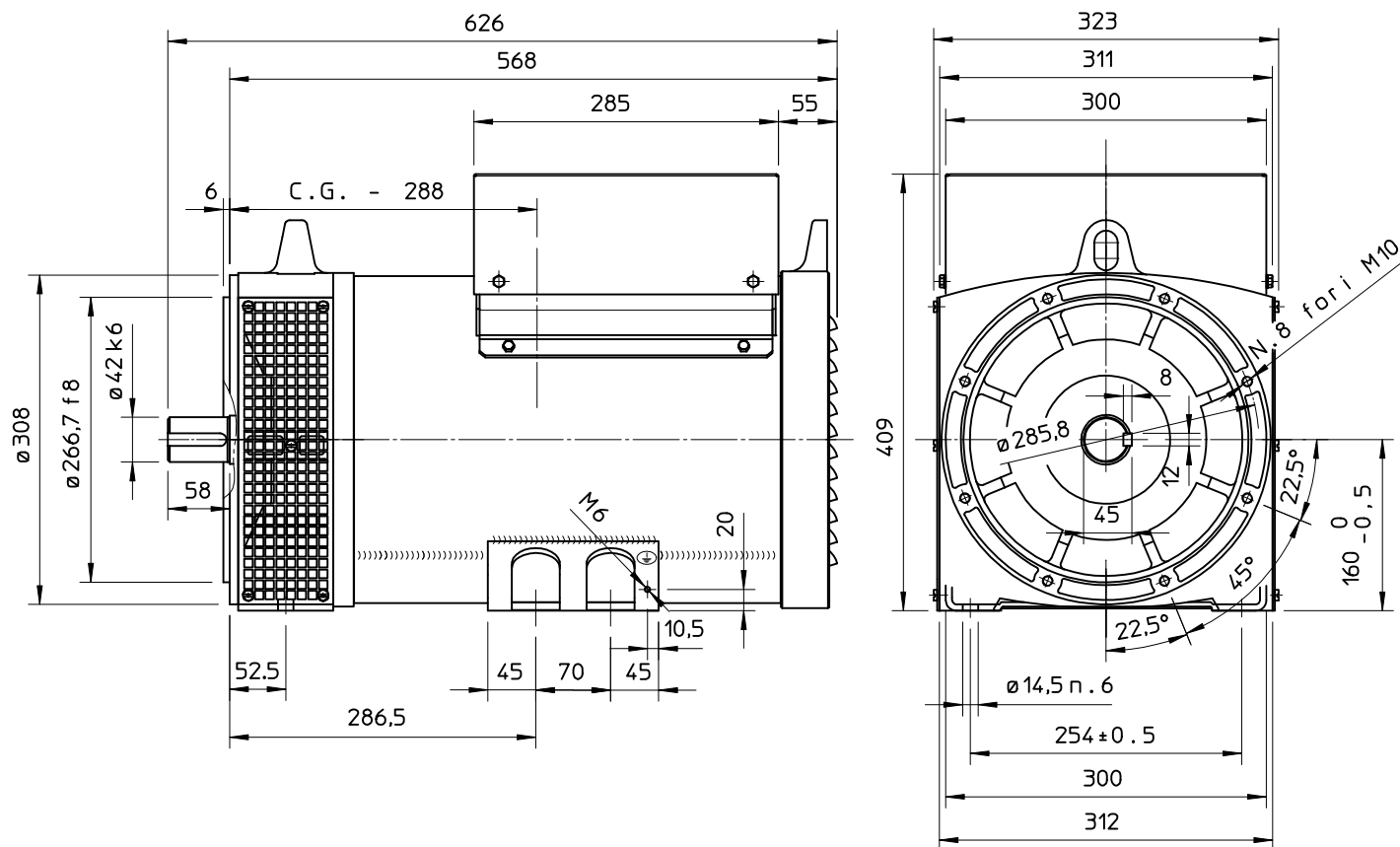

C.G. = GRAVITY CENTER

SINGLE BEARING MOMENTS OF INERTIA

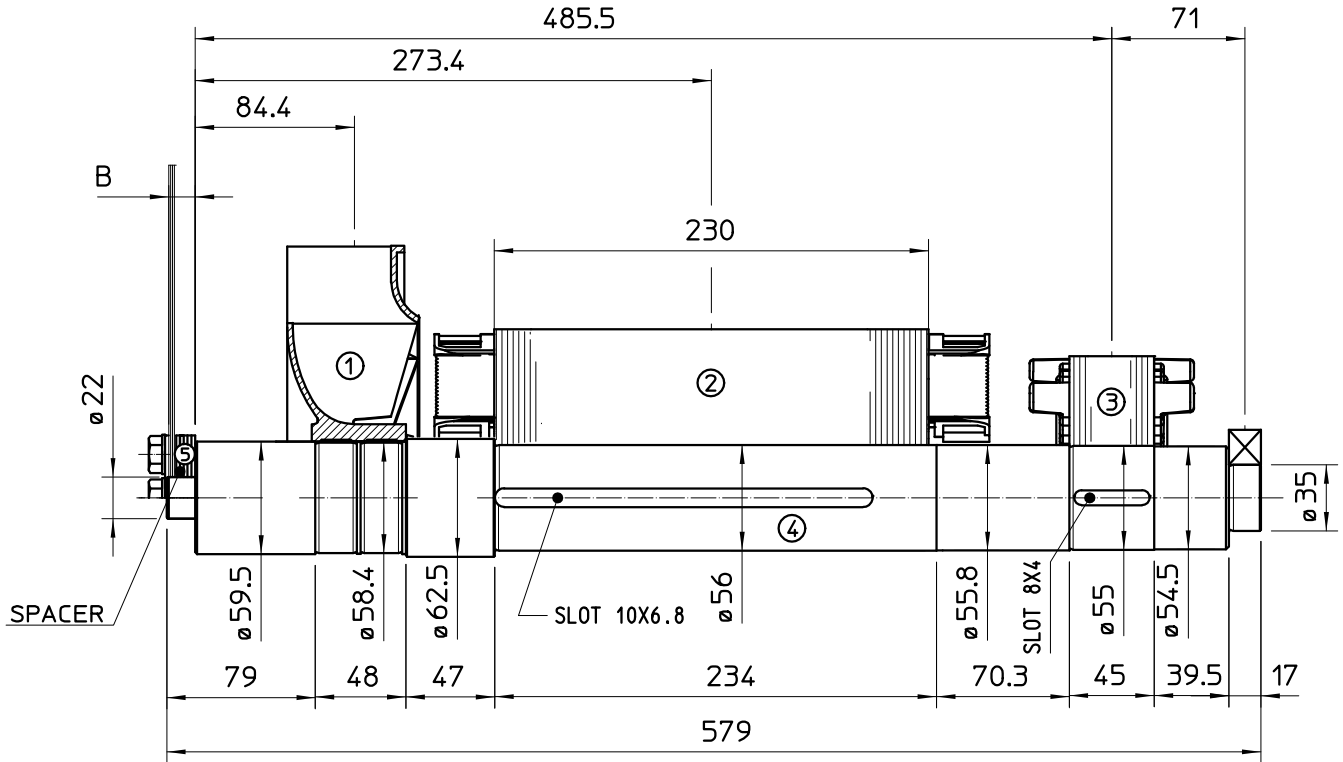

COMPONENT	WEIGHT Kg	J Kg ^{m²}
1 FAN	1.2	0.0102
2 MAIN ROTOR	32.4	0.138
3 EX ROTOR	5.4	0.012
4 SHAFT	11.2	0.0044
6 TOTAL	50.2	0.1646

SAE N.	B (mm)	SHAFT COUPLING FLEX PLATE	WEIGHT kg	J kg ^{m²}
6 1/2	4		1.14	0.0067
7 1/2	4		1.42	0.0103
8	35.6		1.97	0.0171
10	27.6		2.59	0.0319
11 1/2	14		3.1	0.0481

SINGLE BEARING DIMENSIONS

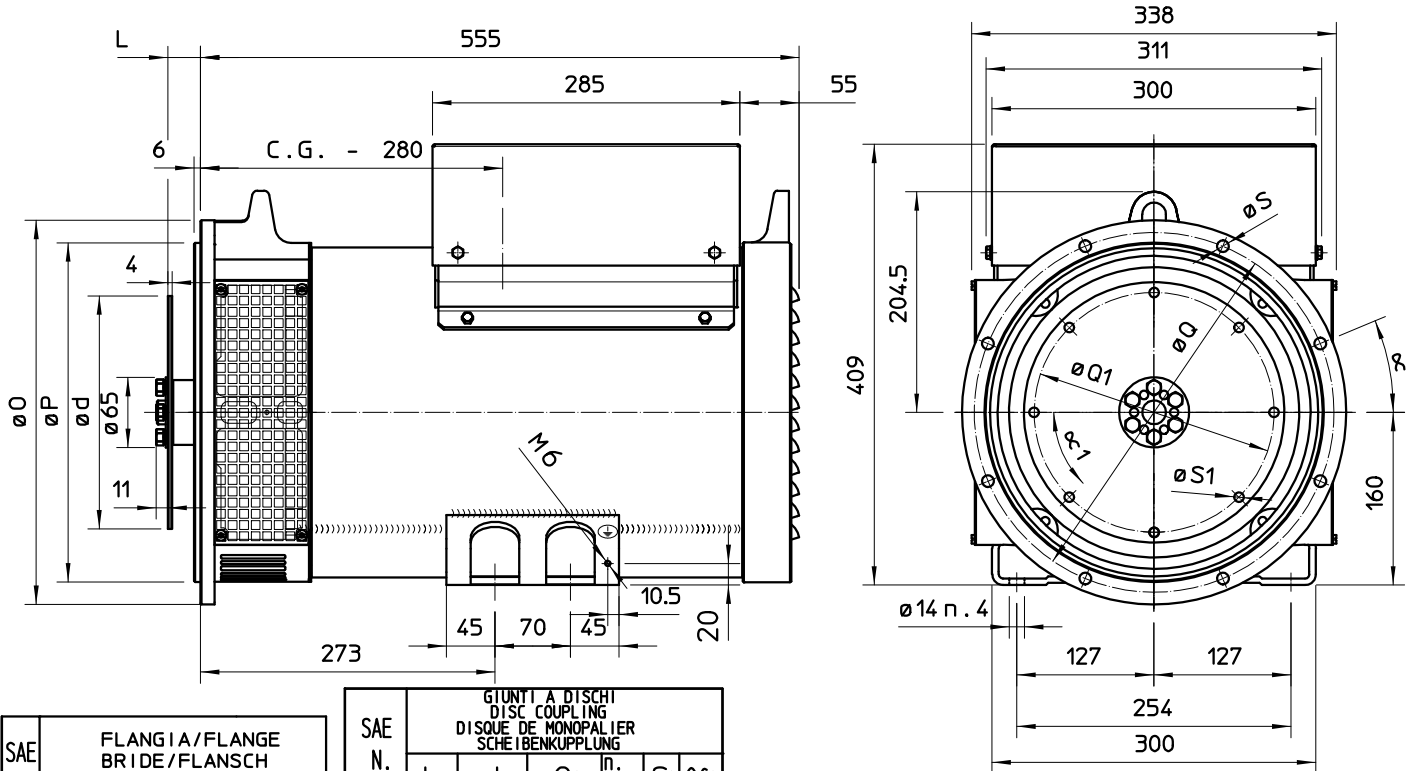

SAE N.	FLANGIA/FLANGE BRIDE/FLANSCH					
	O	P	Q	n. fori	S	α
5	356	314.3	333.4	8	11	22°30'
4	403	362	381	12	11	15°
3	451	409.6	428.6	12	11	15°
2	489	447.7	466.7	12	11	15°

SAE N.	GIUNTI A DISCHI DISC COUPLING DISQUE DE MONOPALIER SCHEIBENKUPPLUNG					
	L	d	Q1	n. fori	S1	α1
6 1/2	30.2	215.9	200	6	9	60°
7 1/2	30.2	241.3	222.25	8	9	45°
8	62	263.52	244.47	6	11	60°
10	53.8	314.32	295.27	8	11	45°
11 1/2	39.6	352.42	333.37	8	11	45°

C.G. = GRAVITY CENTER